

**Bora-Care<sup>®</sup>**  
**Technical**  
**Bulletin**

NEW CONSTRUCTION TREATMENTS  
FOR THE PREVENTION OF

# Subterranean Termites

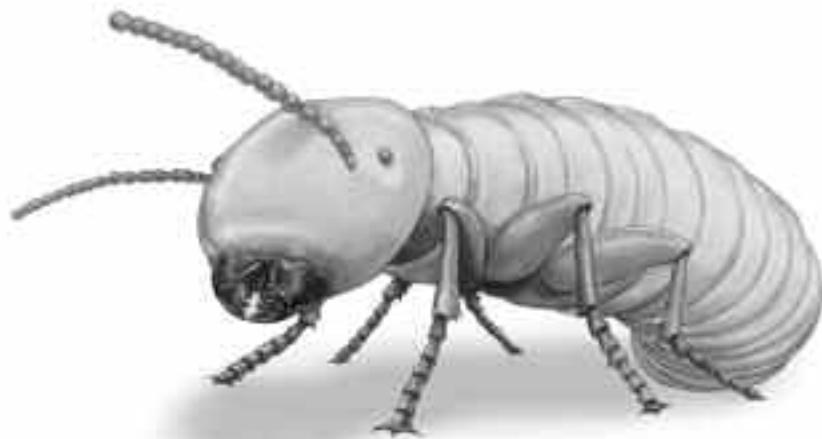

# BORA-CARE® TECHNICAL BULLETIN

## NEW CONSTRUCTION TREATMENTS FOR THE PREVENTION OF SUBTERRANEAN TERMITES

*(ALWAYS READ LABEL COMPLETELY BEFORE ANY APPLICATIONS.)*

**BORA-CARE** Termiticide, Insecticide and Fungicide is a highly effective, long-lasting pesticide that can be used as a primary application against subterranean termite infestation in new construction. Rather than creating a toxic barrier in the soil surrounding a home or structure, BORA-CARE is designed to treat the termites' food source (wood and other cellulosic materials) and to create a barrier on non-cellulosic materials and entry points. BORA-CARE rapidly penetrates wood components and provides a long-term, continuous barrier of protection against future infestations when applied to bare wood, concrete and masonry, pipe penetrations, bath traps and other subterranean termite entry points.

Since its introduction to the pest control industry in 1990, BORA-CARE has been used to protect wood against wood destroying organisms. In 1999, the U.S. Department of Housing and Urban Development (HUD) allowed the use of EPA-labeled wood pretreatments—such as BORA-CARE—as stand-alone termite preventative treatments on new construction. Bora-Care is also among the field-applied wood treatments that can be used per section R320.2 of the updated 2006 International Residential Code.

BORA-CARE may be used on all cellulosic materials including wood, plywood, particle board, paper, oriented strand board (OSB), cardboard and wood composite structural components. It is also applied to concrete block, metals, PVC plumbing pipes, bath traps and other non-cellulosic materials found in structures as part of a preventative subterranean termite treatment. When a 1:1 solution of BORA-CARE is applied as a full continuous horizontal and vertical application to all structural wood in a two-foot band on slab or crawl space/basement structures, foundations, bath traps, pipe protrusions and other areas, it will prevent

subterranean termites from damaging wood or “tubing” over treated wood, foundations or other treated components to reach untreated areas of the structure.

### HOW BORA-CARE COMPARES TO OTHER TERMITICIDES

BORA-CARE is packaged as a liquid concentrate that contains 40% Disodium Octaborate Tetrahydrate (DOT) active ingredient. BORA-CARE is water-soluble and incorporates a patented glycol mixture that enhances penetration and absorption of DOT into wood. BORA-CARE is a low toxicity product that does not adversely affect the environment. Since BORA-CARE is only applied to the termites' food source and entry points, less pesticide is required around the home. In addition, BORA-CARE has very low odor and the treated wood can be handled when dry. Due to its outstanding performance as a preventative treatment, ease of application, fewer environmental concerns for workers and applicators and ease of scheduling, BORA-CARE new construction treatments are often used in place of soil pretreatments.

### WHY BORA-CARE WORKS

BORA-CARE provides double protection by acting as both a toxicant via ingestion and a deterrent to termite tubing. This means that termites are kept out of structures, preventing wood damage. Compared to other borate products, BORA-CARE provides the highest level of active ingredient against termites, and is the only borate-based termiticide with long-term efficacy studies against subterranean termites.

Twelve years of efficacy tests performed in Gulfport, MS by USDA Forest Service and Mississippi State

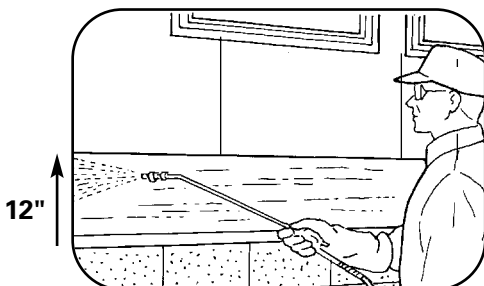

Treating the exterior of a crawl space/basement structure.

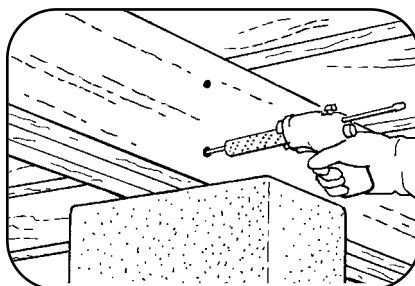

If desired, JECTA is injected into tripled or quadrupled support members to insure coverage.

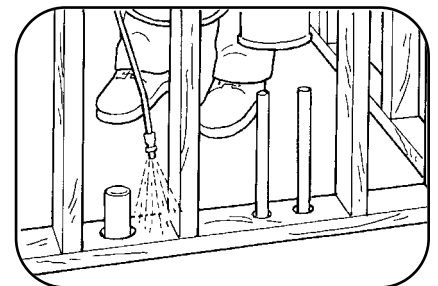

Interior and exterior walls, the slab, plumbing penetrations and bath traps are treated on slab structures.

University have emphatically demonstrated BORA-CARE's ability to stop subterranean termites from tubing over treated wood. Wood treated with BORA-CARE and subjected to intensive termite pressure showed no signs of termite damage or tubing after twelve years, while the untreated control wood was completely destroyed. In addition, tests conducted at Louisiana State University have shown that BORA-CARE applied to concrete and foam surfaces will prevent Formosan termite tubing.

### NEW CONSTRUCTION TREATMENTS WITH BORA-CARE

Structures may be treated with BORA-CARE as a primary treatment during the construction process when access to all structural wood members and foundations is available. Normally this is at the "dried-in" stage of construction when all structural wood and sheathing is in place and prior to installation of drywall, insulation, mechanical systems and electrical wiring. Apply BORA-CARE only to bare wood, plywood, particle board and other cellulosic materials where an intact water repellent barrier, such as paint, stain or sealer, is not present.

In new construction applications for the prevention of subterranean termites, structural wood is defined as only wood needed for the basic building structure, as found in the dried-in stage of construction, including wood in direct contact with foundations, interior and exterior wall sill plates, wood studs, wood or cellulosic sheathing, floor joists and sub-flooring.

**NOTE: "60% Rule"** – see label for structures with little wood in contact with the foundation.

The 60% should be determined by measuring the lineal footage of all continuous horizontal cellulosic base plates in contact with slab, exterior wall or foundation wall and this lineal footage should be expressed as a percentage of the total interior and exterior walls of the structure. In a qualifying home with 60% cellulosic base plates, all structural components regardless of

whether they are wood or not, must be treated to a height of two feet as per the label (including concrete block and steel studs).

### CALCULATING THE AMOUNT OF BORA-CARE REQUIRED FOR NEW CONSTRUCTION TREATMENTS

BORA-CARE applications on wood are based on treating board feet of lumber. Measurement of the structure is key to determine the amount of BORA-CARE solution required for label application. One accurate and fast method to accomplish this is to use a measuring wheel to measure the linear footage of outside foundations on all structures and the linear footage of inside stud wall areas (as required in slab structures).

To determine the amount of BORA-CARE needed to treat structural wood components and other label applications in new construction treatments, check the Application Rates table on the BORA-CARE label, or use the *Application Rate Chart* or *Bora-Care New Construction Application Worksheet* found at the end of this bulletin. The *Application Rate Chart* lists various construction foundations and gives instructions and amounts of BORA-CARE to be used on both wood and non-cellulosic areas, and is based on registered label applications. The *Bora-Care New Construction Application Worksheet* shows a simple way to total all application areas. (This worksheet is available for download as an interactive spreadsheet from [www.nisuscorp.com](http://www.nisuscorp.com).)

**NOTE:** The quantity of BORA-CARE needed for lineal or square feet of wood remains the same whether applying one application to all sides of the wood, or when applying two coats of solution to one to two sides of a wood component.

### MIXING BORA-CARE

BORA-CARE concentrate must be mixed with water as a 1:1 (one part BORA-CARE concentrate to one part water), per labeled requirements, for all subterranean

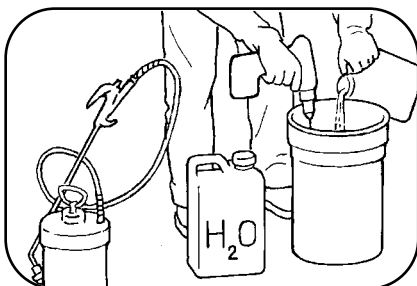

Mixing is a simple but important first step.

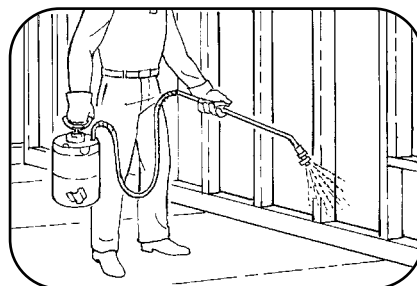

Treating an exterior wall and sheathing on a slab structure.

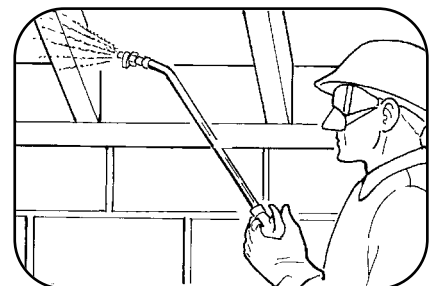

Treating the sill, band joist, subfloor and floor joists in a crawl space/basement structure.

## Barrier Treatment for Slab Construction Two-Foot Band Treatment

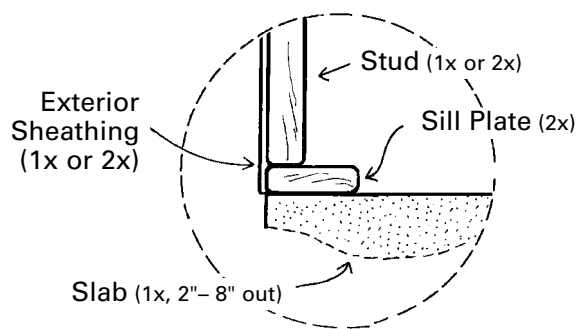
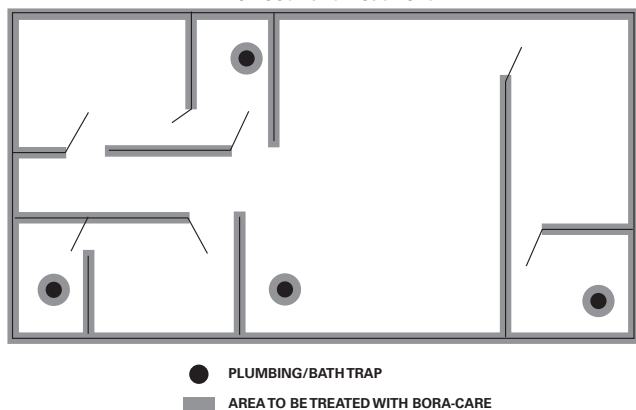

Areas to be treated on a slab.

termite prevention or control applications. For example, on single family homes, you may need only two to four gallons of BORA-CARE solution (one to two gallons of concentrate) for the labeled 24-inch band new construction treatment.

To mix up to four gallons of BORA-CARE solution you will need the following equipment and materials:

1. A five-gallon pail
2. Water
3. Drill
4. Mixing impeller (like those used to mix paint; preferably plastic)
5. Recommended personal protective equipment, including long-sleeved shirt, gloves and eye protection.
6. BORA-CARE concentrate.

To make it easier to see where BORA-CARE solutions have been applied, an appropriate dye or colorant may be added to the solution when diluting BORA-CARE with water. Refer to the dye/colorant product label for recommended amount to add to the BORA-CARE solution. NOTE: It is not recommended to use a marker dye or pigment in BORA-CARE solutions on surfaces that will be visibly exposed upon completion of construction and aesthetically displeasing to the builder or potential home buyer. Where dye/colorant application is required by individual state rules but not used for aesthetic reasons in certain areas, be sure to document where and why a dye/colorant was *not* applied. Dye/colorant color or darkness does not indicate the amount or concentration of BORA-CARE applied. If dye/colorant is applied to non-target areas, be sure to clean with water immediately.

To mix a 1:1 solution, put 3/4 amount of the water required into tank and begin mechanical agitation while gradually adding the required BORA-CARE. Use remaining water to triple-rinse BORA-CARE containers,

then add this to the tank solution and agitate until thoroughly mixed.

*Remember:* Only mix enough BORA-CARE 1:1 solution needed for that day's applications. The 1:1 solution is not to be stored in the spray tank or other container for more than 24 hours. Refer to label for specific directions.

### EXAMPLE:

#### To mix two gallons of BORA-CARE 1:1 solution:

1. Pour 3/4 gallon of water into a five-gallon pail.
2. Attach mixing impeller to drill and begin agitation.
3. Gradually pour one gallon of BORA-CARE into water and continue to mix solution.
4. Use remaining 1/4 gallon of water to triple rinse the BORA-CARE container and pour contents into mixing solution.
5. Continue to mix until solution becomes clear or you do not feel resistance of any remaining concentrate. Normal mixing time may be 5-10 minutes.

#### Mixing tips:

- If using a metal mixing impeller, do not allow the impeller to touch sides or bottom of pail. This may create small plastic chips that could clog spraying equipment.
- Warm water may reduce mixing time, but is not required.

Many companies are using a 1-2 gallon hand-held stainless steel sprayer, backpack sprayer or a Nisus-approved unit designed for BORA-CARE applications to apply 2-4 gallons of BORA-CARE solution per new construction treatment. If larger amounts of BORA-CARE solution are needed, a 15-25 gallon Nisus-approved spray unit is recommended. For best results, this unit should have agitation for proper mixing to prevent any potential clogging of spray equipment.

## TREATMENT APPLICATION TECHNIQUES FOR DIFFERENT STRUCTURES

### TREATMENT FOR SLAB STRUCTURES

A slab new construction treatment with a 1:1 solution of BORA-CARE consists of creating a full continuous horizontal and vertical barrier by treating all areas that termites could come into contact with first, including structural wood and foundations. This includes structural wood of both internal and external walls (sill plates, wall studs and exterior wood sheathing), foundations (concrete surfaces), bath traps, pipe protrusions and other areas. Interior walls must be

treated to prevent termite entry due to cracks that may occur in the slab.

**Stud Walls:** All accessible sides (3-4 sides) of the studs are treated with one coat from the sill plate up vertically 24 inches high. If access to a wood stud is limited to one or two sides, then spray the accessible sides with two coats of solution, waiting 20 minutes between applications. In treating sills, spray the sill plate with two coats of BORA-CARE 1:1 solution, extending horizontally out on the slab two to eight inches from the sill, and waiting 20 minutes in between coats. To determine the amount of BORA-CARE needed to treat sill plates and studs, measure the linear

**EXAMPLE:** A slab home that measures 55 feet by 45 feet has a total of 200 linear feet of perimeter walls. Those walls are covered with 3/4 inch OSB sheathing. The interior wooden stud walls add up to be 100 linear feet. There are two bath traps, each one square foot in area.

The calculations for the stud walls, bath traps and the OSB sheathing are handled separately.

• **All Stud Walls:** Take the total linear footage of both interior and exterior stud walls, in this case, 300 feet. The chart states that 1 gallon of BORA-CARE solution will cover 200 linear feet of stud wall, so divide 300 by 200. This calculation yields a sum of 1.5. It will take **1.5 gallons** of BORA-CARE 1:1 solution to cover the stud walls, slab and all pipe and plumbing penetrations.

**1.5 gallons**

*(interior and exterior stud walls,  
pipe & plumbing penetrations)*

• **Bath Traps:** The number of bath traps must be multiplied by 0.125 (based on 16 oz. per sq. ft. of bath trap). In this example, two bath traps will require **0.25 (1/4) gallons** of BORA-CARE 1:1 solution.

**+0.25 gallons** (32 oz.)

*(2 bath traps)*

• **Sheathing:** A 24-inch (two-foot) band of sheathing is to be treated. Take the total linear footage of the perimeter of the structure, in this case 200, and multiply by 2 to determine square footage. This yields 400 square feet of sheathing to be treated. Divide this 400 square feet by 400 (the number of square feet of sheathing the chart states will be covered by 1 gallon of BORA-CARE 1:1 solution). This calculation yields a sum of 1. It will take **1 gallon** of BORA-CARE 1:1 solution to treat a two-foot band once on each side (or two sides twice) of the sheathing.

**+1.0 gallons**

*(exterior wall sheathing)*

• **Total Amount of BORA-CARE Solution:**

Figure the total amount of BORA-CARE solution by adding the three figures (for your particular numbers, use the *Bora-Care New Construction Application Worksheet*). **For this structure, 2.75 gallons of BORA-CARE solution are required.**

---

**= 2.75 gallons** total Bora-Care solution

• **Total Amount of BORA-CARE concentrate:**

To obtain the number of gallons of concentrate required, divide by 2. **For this structure, 1.38 gallons of BORA-CARE concentrate are required.**

**÷2**

---

**1.38 gallons** total Bora-Care concentrate

footage of interior and exterior stud walls. Once this is obtained, you can determine the amount of BORA-CARE required by checking the "Slab Construction" section of the *Application Rate Chart*. The chart states that one gallon of BORA-CARE solution will cover 200 linear feet of stud walls with a 24-inch vertical application (excluding sheathing). This includes the application of solution 2-8 inches out horizontally on the slab from the sill or plate.

**Exterior Sheathing:** Both sides (interior and exterior) of the bottom 24 inches of exterior sheathing are treated with one coat of 1:1 BORA-CARE solution to provide a continuous vertical barrier. If the sheathing has only one accessible side due to construction materials blocking access to the other side of the sheathing surface, then two coats on the available surface are required. Be sure to document such applications. If the structure has exterior wood sheathing, such as plywood or OSB board, refer to the chart section for "Exterior Sheathing." The chart indicates that 1 gallon of BORA-CARE solution will cover 400 square feet of sheathing. This includes one vertical application of solution on each side or two applications on one side.

**Bath Traps and Pipe Penetrations:** Bath traps, pipe penetrations and the slab areas around them must be treated horizontally and vertically to protect from termite entry into the structure. All bath traps are to be treated horizontally at the rate of 8-16 ounces of BORA-CARE solution per square foot of bath trap area. Treat a 12" band on slab around bath traps to create a continuous horizontal barrier. Treat all pipe and plumbing penetrations to a height of two feet on pipe and plumbing penetrations. Extend treatment at least 6 inches out horizontally from penetrations onto slab surface for any penetrations that are not associated with any structural wood. All pipe and plumbing solutions are already included in the normal solution application calculations to structural wood components.

## Barrier Treatment for Crawl Space Two-Foot Band Treatment

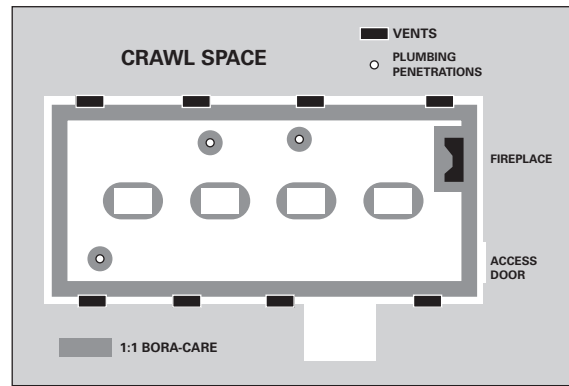

### CRAWL SPACE OR BASEMENT CONSTRUCTION

To create a full continuous horizontal and vertical barrier in crawl space or basement construction, a BORA-CARE new construction treatment will include treating the following:

**Perimeter Elements:** This is composed of the foundation sill plate, header or band joist, floor joists and subfloor.

- Foundation Sill Plate:** Treat horizontally with two coats (assuming only 1-2 sides of the sill plate are accessible) of 1:1 BORA-CARE solution on the foundation sill plate, waiting at least 20 minutes between coats.
- Header or Band Joist:** Treat all accessible sides with one coat of same solution. If only one or two sides are accessible, treat with two coats of solution.
- Floor Joists:** Treat all accessible sides (assuming three sides are exposed) with one coat of BORA-CARE solution. Solution must be applied in a two-foot horizontal band beginning at the sill plate and extending back from the foundation.
- Subfloor:** Apply two coats of solution only on the underside of the wooden subfloor. Both applications

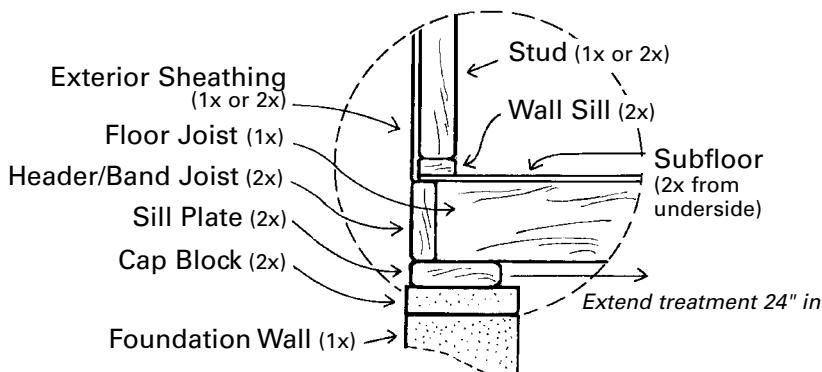

Areas to be treated on crawl space/basement exterior walls.

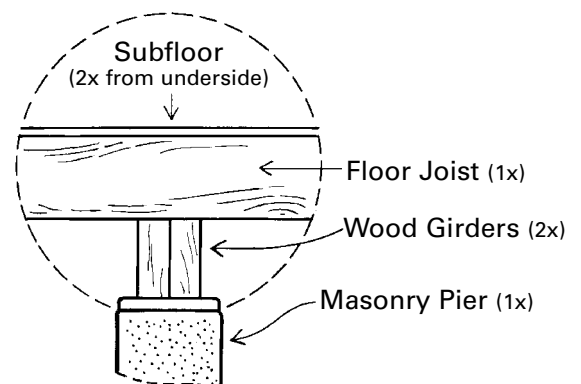

Areas to be treated on a crawl space support pier.

must be applied in a continuous 24" horizontal band beginning at the foundation wall and extending back from the header or band joist.

solution will cover 100 linear feet of foundation sill plates, floor joists, header and subfloor listed above in a two-foot band. To obtain the amount of BORA-CARE solution needed, divide the total linear feet of the outside perimeter by 100.

The *Application Rate Chart* simplifies calculations by combining the four construction elements (sill plate, floor joists, subfloor and header or band joist) into one unit that can be measured in linear feet. Measuring the outside perimeter of the building (or all sill plate areas resting on foundation walls) is the first step.

**Concrete-Masonry Foundation Support Piers:** Treat all wood members that come in contact with the support pier with a 24-inch continuous horizontal barrier. Horizontally treat all wood two feet (24 inches) out from contact with pier. This includes the subfloor, floor joists and any other wood in contact with the support

The chart states that 1 gallon of BORA-CARE 1:1

**EXAMPLE:** A crawl space home is 55 feet long by 45 feet wide. It has 200 total linear feet of sill plate resting on foundation walls and 10 foundation piers (each 2'x2', or 8 linear feet, of pier foundation).

• **Perimeter elements (sill plate, header, floor joists & subfloor):**

Divide 200 linear feet of sill plates by 100 (the number of linear feet of treated perimeter elements covered by one gallon of BORA-CARE solution). This yields **2 gallons** of BORA-CARE solution.

**2.0 gallons**

*(perimeter wood elements)*

• **Support Piers in Contact with Wood:** Multiply 10 piers X 8' (8 linear feet of wood elements per pier). This equals 80 linear feet. Divide 80 by 100 (the number of linear feet of treated crawl space area covered by one gallon of BORA-CARE solution). This yields **0.8 gallons**.

**+0.8 gallons**

*(wood in contact with support piers)*

• **Exterior Vertical Treatments:** To complete the two-foot (24-inch) vertical treatment requirement on sheathing and wall areas, measure the linear feet (200 linear feet) and divide by 160 to yield **1.25 gallons**. This solution will treat the 1 foot (12 inches) of wood areas above the box header/box/sill to include edge of sub-floor, sill plate resting on sub-floor, stud wall and exterior sheathing. NOTE: This application is only needed on exterior walls and is not needed on interior walls.

**+1.25 gallons**

*(exterior walls only)*

• **Concrete-Masonry Foundation Walls:** Measure the linear footage of the concrete perimeter foundation wall *and* the linear footage around any foundation piers. This equals 280 linear feet (200 l.f. of perimeter walls and 80 l.f. of support piers). Next, multiply this total by 2 to get square footage of treatment surfaces. This equals 560 sq. ft. Vertically treat two feet (24 inches) up from ground. One gallon of solution will treat 400 sq. ft. of wall surface area. 560 sq. ft. divided by 400 gives 1.4 gallons of solution needed.

**+1.40 gallons**

*(concrete-masonry foundation walls)*

• **Total Amount of BORA-CARE Solution:**

Total the above amounts for perimeter elements, external vertical treatments, support piers and concrete/masonry foundation walls to obtain the total gallons of BORA-CARE solution needed.

**For this structure, 5.45 gallons of solution are needed.**

---

**= 5.45 gallons** *total Bora-Care solution*

• **Total Amount of BORA-CARE Concentrate:**

To obtain the number of gallons of concentrate required, divide total gallons of solution by 2. **For this structure, 2.73 gallons of concentrate are needed.**

**+2**

---

**2.73 gallons** *total Bora-Care concentrate*

pier. Normal crawl space piers should be measured at eight linear feet of treatment area per pier. To obtain the amount of BORA-CARE solution needed, multiply the number of piers by eight and divide by 100 (the number of linear feet covered by 1 gallon of BORA-CARE solution).

All concrete/masonry support piers are to be treated up two feet (24 inches) vertically from the ground. Measure the linear footage of concrete-masonry foundation support piers and multiply by 2. Treat this area vertically two feet high from the sill or slab at a rate of 1 gallon of solution per 400 sq. ft. of surface area.

**Crawl Space Concrete-Masonry Foundations:** Measure in front of all concrete-masonry foundation walls. Treat all interior concrete-masonry wall surfaces up vertically two feet (24 inches) from the basement slab or crawl space soil. Horizontally extend 2-8 inches out on slab surfaces in basements or crawl spaces. Treat at the rate of 1 gallon (1:1) solution per 400 square feet of treated surface area.

**Exterior Vertical Treatments:** After application to perimeter elements in contact with the foundation (which comprises the first 12" of the 24" treatment), vertically treat an additional one foot (12 inches)—above top of subfloor/box header/sill—of the exterior foundation walls, to include stud walls, sheathing and sill plate located above the sub-floor. Treat with one coat of BORA-CARE 1:1 solution on both sides of sheathing (or two coats on the interior side of sheathing if both sides are not accessible). Apply one gallon of a 1:1 BORA-CARE solution to 160 linear feet of wood area.

This application completes the two-foot (24-inch) vertical continuous barrier treatment requirement from the foundation because the 12" (1 foot) box header/sill was previously treated when BORA-CARE was applied to the foundation sill and joist area (see *Application Rate Chart*)

**Finished Basement Areas:** NOTE: This is in addition to the previously described Perimeter Elements and in addition to horizontally treating the foundation sill plate, header, floor joist and sub-floor with a 24-inch treatment as described above.

Treat all interior wood stud walls, pipe penetrations and bath traps as described in the slab instructions with a continuous vertical two-foot (24-inch) band on stud framing.

Vertically and horizontally treat interior wood stud

walls in contact with the basement / foundation slab as you would treat wood stud walls as described on a concrete slab at the rate of 1 gallon of (1:1) solution per 200 linear feet with a 24-inch vertical band treatment. (See *Application Rate Chart*).

Treat all vertical wood structural walls located within three inches of or touching masonry-concrete foundation walls, to include slab sill plates, entire stud elements and top plate (or runner).

Vertically treat all wood (e.g., stud walls) attached to all solid foundation walls at the rate of 1 gallon per 50 linear feet with a (1:1) solution.

### **SPECIAL APPLICATIONS**

There are some special application situations where other treatments may be used. When multiple boards are bonded together to form a wide beam or girder, then they may be drilled and injected with JECTA® (a concentrated borate gel designed to be injected into thick or sealed wood components) at the point where they come into contact with the foundation.

Hidden void areas or areas where there may be structural wood that may not be accessible by normal treatment methods may be injected or treated with a foaming application in order to create a continuous vertical and horizontal barrier. Always refer to the BORA-CARE and JECTA labels for specific instructions.

### **DOCUMENTATION**

It is very important to graph the structure and fully document the BORA-CARE application, including where dye or colorant was not used (if used in part of the structure), areas that were not accessible (such as only one side of sheathing) and so forth. This documentation will be a very important tool for future inspections.

### **CUSTOMER COMMUNICATION**

It is also very important to talk to the builder or, if possible, to the home buyer to explain the treatment and educate them on conducive conditions that could cause termite infestation and the need for the pest management professional to do a thorough on site annual inspection to determine if any conducive conditions have been created. Any product is only as good as the application, and because you are a pest management professional, we hope you will utilize this information to protect you, your company and—most importantly—the new home buyer from potential termite infestation and damage.



## APPLICATION SAFETY

Before beginning any chemical treatment, it is important to consider safety in application. According to the BORA-CARE label, the applicator must wear a long-sleeved shirt, long pants, socks, shoes, chemical resistant gloves and protective eye wear. When applying BORA-CARE in a confined area it is recommended to wear a NIOSH approved respirator when ventilation is not provided. Spills or over-spray can be cleaned with a damp cloth or absorbed with appropriate materials. (Read label for complete safety information.)

## WARRANTY LIMITATIONS AND DISCLAIMER

### Warranty Disclaimer

Manufacturer warrants that this product conforms to the chemical description on the label and is reasonably fit for the purposes stated on the label when used in strict accordance with the directions, subject to the inherent risks set forth below. **MANUFACTURER MAKES NO OTHER EXPRESS OR IMPLIED WARRANTY OF MERCHANTABILITY OR FITNESS FOR A PARTICULAR PURPOSE OR ANY OTHER EXPRESS OR IMPLIED WARRANTY.**

### Inherent Risks of Use

It is impossible to eliminate all risks associated with use of this product. Lack of performance or other

unintended consequences may result because of such factors as use of the product contrary to label instructions, abnormal conditions, the presence of other materials, the manner of application or other factors, all of which are beyond the control of the seller. All such risks shall be assumed by the buyer.

### Limitation of Remedies

The exclusive remedy for losses or damages resulting from this product (including claims based on contract, negligence, strict liability or other legal theories) shall be limited to, at Manufacturer's election, one of the following:

1. Refund of purchase price paid by buyer or user for product bought, or
2. Replacement of amount of product used.

Manufacturer shall not be liable for losses or damages resulting from handling or use of this product unless Manufacturer is promptly notified of such loss or damage in writing. **IN NO CASE SHALL MANUFACTURER BE LIABLE FOR CONSEQUENTIAL OR INCIDENTAL DAMAGES OR LOSSES, INCLUDING WITHOUT LIMIT, HEALTH RELATED DAMAGES OR INJURIES.** The terms of this Warranty Disclaimer and Limitation of Remedies cannot be varied by any written or verbal statements or agreements. No employee or sales agent of Manufacturer or the seller is authorized to vary or exceed the terms of this **Warranty Disclaimer** or **Limitation of Remedies** in any manner.



*The World's Leader in Borate Technology*

100 Nisus Drive • Rockford, TN 37853 • 800.264.0870 • [www.nisuscorp.com](http://www.nisuscorp.com)

Bora-Care and Nisus are registered trademarks of Nisus Corporation. ©2006 Nisus Corporation #NCTB-0107a

# APPLICATION RATE CHART for Subterranean and Formosan Termites

## *Bora-Care New Construction 2-Foot Vertical & Horizontal Treatment*

For whole house wood treatment, active infestation treatment or drywood termite prevention, refer to the *BORA-CARE Termite Technical Bulletin* or the *Drywood Termite Technical Bulletin*.

The application rates and instructions on this chart are based on standard building practices and materials. All application rates are based on BORA-CARE label instructions. **Always read the BORA-CARE label before application.**

TYPE OF TREATMENT		WHEN TO USE	APPLICATION INSTRUCTIONS	COVERAGE PER 1 GALLON OF 1:1 SOLUTION
<b>SLAB</b>	<b>Slab Foundation</b> (wood & concrete)	Use as preventive treatment against termites.	Apply to sill/base plate and 24" up on studs and other wood members in contact with slab foundation. Apply second coat on sill.  Spray concrete 2"-8" horizontally out from sill or base plate. Treat all pipe protrusions within stud walls or free standing in slab 24" up from slab and extending horizontally 6" out on the slab surface.	200 linear feet (Measure linear feet of stud walls to be treated)
	<b>Sheathing</b> (wood)		Vertically apply to both sides of exterior sheathing to point of wetness. If one side is inaccessible, apply two coats to one side at least 20 minutes apart.	400 square feet (Measure area: length X width)
	<b>Bath Traps</b>	To prevent entry of termites.	Apply into bath trap area and extend at least 1' out onto slab surface.	8-16 ounces of solution per square foot of bath trap area
<b>CRAWL SPACE</b>	<b>Crawl Space</b> (wood)	Use as preventive treatment against termites.	Apply to all wood in a 24" area from exterior wall (to include sill plate, header joist, floor joists and subfloor). Apply second coat on sill and header joist. Apply to all wood in contact with foundation pier out 24" from foundation pier.	100 linear feet (Measure linear feet of all foundation walls & piers to be treated)
	<b>Up From Soil</b> (concrete)	To complete the 2' vertical treatment requirement on interior surface of foundation walls.	Measure linear footage of concrete-masonry foundation wall <i>and also</i> around each foundation pier, and multiply by 2 to get square footage of treatment area. Apply to foundation wall and piers 24" up from soil.	400 square feet (Measure area: length X width)
	<b>Exterior Wall Vertical Treatment</b> (wood)	To complete the 2' vertical requirement for exterior foundation treatments.	Apply up 12" up onto structural wood components above the top of the header joist (to include the edge of the sub-floor, sill above sub-floor, stud wall and exterior sheathing).	160 linear feet (in addition to amounts listed above)
<b>BASEMENTS</b>	<b>Basement</b>	Use as preventive treatment against termites.	Apply to all wood in a 24" area from exterior wall (to include sill plate, header joist, floor joists and subfloor). Apply second coat on sill and header joist.	100 linear feet (Measure linear feet of all foundation walls & piers to be treated)
	<b>Up From Concrete</b>	To complete the 2' vertical treatment requirement on interior surface of foundation walls.	Measure linear footage of concrete-masonry foundation wall, and multiply by 2 to get square footage of treatment area. Apply to foundation wall 24" up from concrete.	400 square feet (Measure area: length X width)
	<b>Exterior Wall Vertical Treatment</b> (wood)	To complete the 2' vertical requirement for exterior foundation treatments.	Apply up 12" up onto structural wood components above the top of the header joist (to include the edge of the sub-floor, sill above sub-floor, stud wall and exterior sheathing).	160 linear feet (in addition to amounts listed above)
	<b>Bath Traps</b>	To prevent entry of termites.	Apply into bath trap area and extend at least 1' out onto slab surface.	8-16 ounces of solution per square foot of bath trap area
	<b>Finished Basement</b>	Additional treatment required for finished basement.	<b>Walls in contact with foundation:</b> Vertically apply to all wood including sill plate, total stud boards and all the top plate (or runner). Vertically treat all plumbing protrusions (as listed under slab construction). Spray slab 2"-8" horizontally out from sill or base plate.  <b>Interior Walls:</b> Apply to sill/base plate and 24" up on studs and other wood members in contact with slab foundation. Apply second coat on sill. Spray concrete 2"-8" horizontally out from sill or base plate.  Treat all pipe protrusions within stud walls or free standing in slab 24" up from slab and extend horizontally 6" out on the slab surface.	50 linear feet (Measure linear feet of all stud wall sills attached to solid foundation)  200 linear feet (Measure linear feet of stud walls to be treated)

# BORA-CARE NEW CONSTRUCTION APPLICATION WORKSHEET

(2 ft. Barrier Treatment)

## ■ SLAB AREAS

**LINEAR FEET OF ALL EXTERIOR WOOD STUD WALLS** ..... \_\_\_\_\_  
 (Treat sills, slab & 24" vertical band)

**LINEAR FEET OF ALL INTERIOR WOOD STUD WALLS** ..... + \_\_\_\_\_  
 (Treat sills, slab & 24" vertical band)

*NOTE: Plumbing penetrations included in calculations.* = \_\_\_\_\_  
 (Total linear feet of stud walls)

÷ 200 = **A.** \_\_\_\_\_

**NUMBER OF BATH TRAPS** ..... \_\_\_\_\_  
 (16 oz. / sq. ft.)

x .125 = **B.** \_\_\_\_\_

**LINEAR FEET OF ALL EXTERIOR SIDING WALLS** ..... \_\_\_\_\_  
 (Treat exterior plywood or OSB siding 24" vertical band; amounts same for  
 treating both sides once or on one side twice.)

x 2 = \_\_\_\_\_

÷ 400 = **C.** \_\_\_\_\_  
 (Square feet of siding)

**TOTAL GALLONS OF BORA-CARE 1:1 SOLUTION NEEDED (A+B+C) =** .....

## ■ CRAWL SPACE OR BASEMENT AREAS

**LINEAR FEET OF SILL PLATES ON FOUNDATION (wood)** ..... \_\_\_\_\_  
 (Treat foundation sill plate, header, floor joists & subfloor as a 24" horizontal band.)

**LINEAR FEET OF WOOD ELEMENTS AROUND PIERS** ..... (number of piers: \_\_\_\_\_ x 8) + \_\_\_\_\_  
 (Treat all wood in contact with pier in 24" horizontal band.)

= \_\_\_\_\_  
 (Total linear feet)

÷ 100 = **A.** \_\_\_\_\_

**LINEAR FEET OF EXTERIOR WOOD STUD WALLS** ..... \_\_\_\_\_  
 (Treat exterior walls, sills, studs & sheathing 12" above  
 box header & sills to satisfy 2' rule.)

÷ 160 = **B.** \_\_\_\_\_

**LINEAR FEET OF ALL CRAWL SPACE/BASEMENT CONCRETE WALLS (wood)** ..... \_\_\_\_\_  
 (Measure linear feet around support piers and foundation. Treat 24" vertical band.)

x 2 = \_\_\_\_\_  
 (Square feet)

÷ 400 = **C.** \_\_\_\_\_

**LINEAR FEET OF ALL INTERIOR STUD WALLS (finished basement)** ..... \_\_\_\_\_  
 (Treat sills, slab & 24" vertical band.)

*NOTE: Plumbing penetrations included in calculations.* ÷ 200 = **D.** \_\_\_\_\_

**LINEAR FEET OF STUD WALLS AGAINST FOUNDATION (finished basement)** ..... \_\_\_\_\_  
 (Within 3" of foundation, treat entire stud, slab, sill plate on slab & top plate.)

÷ 50 = **E.** \_\_\_\_\_

**NUMBER OF BATH TRAPS (basement slabs only)** ..... \_\_\_\_\_  
 (16 oz. / sq. ft.)

x .125 = **F.** \_\_\_\_\_

**TOTAL GALLONS OF BORA-CARE 1:1 SOLUTION NEEDED (A+B+C+D+E+F) =** .....





*The World's Leader in Borate Technology*

100 Nisus Drive • Rockford, TN 37853 • 800.264.0870 • [www.nisuscorp.com](http://www.nisuscorp.com)

©2006 Nisus Corporation #NCTB-0107a